

BELEUCHTUNG  
FÜR DIE BEREICHE  
ARCHITEKTUR,  
HOTEL, GASTRONOMIE &  
EINZELHANDEL

**-ON**

# Maga Serie Datenblatt

---

## Niedervolt-Magnetschienensystem

---

Ami-Zoom



01

Ami-Filter



02

Cubo



03

Dabo

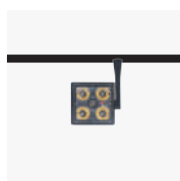

04

Pixy



05

Casa



06

Bande



07

Bande Diffusor



08

Ami-Pendelleuchte



09

Canos



10

Navia

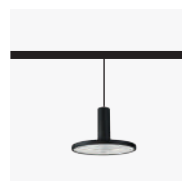

11

Mona

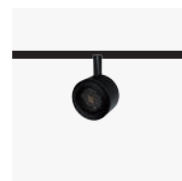

12

Marmor



13

Mika



14

Polo\_50



15

Polo\_70



16

## Einbauleuchten

---

Ami-Rund  
Zoom



17

Ami-Rechteck  
Zoom



18

Ami-Quadrat  
Zoom

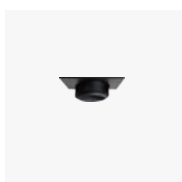

19

Ami-Rund  
Filter

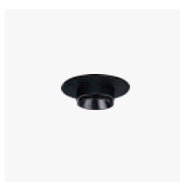

20

Ami-Rechteck  
Filter



21

Ami-Quadrat  
Filter

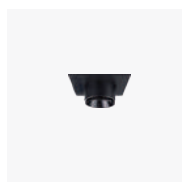

22

# Ami-Zoom Niedervolt-Magnetschienensystem



- Weiß  
● Schwarz

## Merkmale

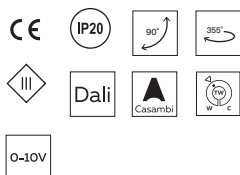

## Maße

### M403

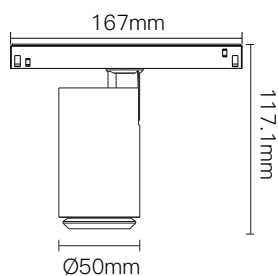

### M412

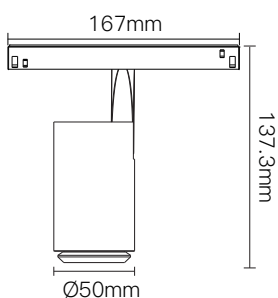

## Elektrisches System

<b>Gesamtenergieverbrauch:</b>	10W
<b>Stromversorgung:</b>	48V
<b>Betriebstemperatur:</b>	-10°C ~ 35°C
<b>Steuerprotokoll:</b>	0-10V / Dali / Casambi
<b>Schutzklasse:</b>	Klasse III

## Lichtquelle

<b>LED-Typ:</b>	COB
<b>CCT:</b>	2700K/3000K/4000K
<b>CRI:</b>	Ra>90
<b>Strahlungswinkel:</b>	18°-45°
<b>UGR:</b>	<16

## Gehäuse

<b>Leuchtkörperdurchmesser:</b>	50mm
<b>Material:</b>	Aluminium, Kunststoff
<b>Gewicht:</b>	271.4g

## Garantie

<b>Zeitraum:</b>	5 Jahre Garantie
------------------	------------------

## Lichtleistung

Winkel \ CCT	2700K	3000K	4000K
18°-45°	288lm	320lm	350lm

## Nomenklatur

\*Gültiges Modell: M40310xx90xxxx (xx: dynamische Codes)

Produktcode	Systemleistung	CCT	CRI	Strahlungswinkel	Antrieb/Steuerung	Seriennummer
M403	10(10W)	27(2700K)	90(90)	Z2(18°-45°)	N(Non-Dim)	01(Black)
M412		30(3000K)			A(0-10V dim)	02(White)
		40(4000K)			D(Dali dim)	
		TW(Tunable)				

# Ami-Filter Niedervolt-Magnetschienenensystem



- Weiß  
● Schwarz

## Merkmale

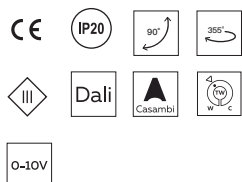

## Maße

### M404

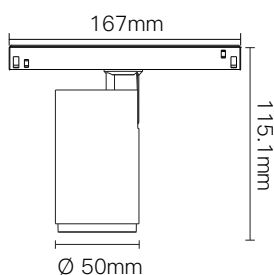

### M413

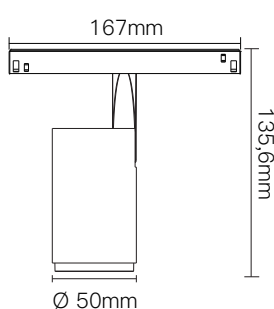

## Elektrisches System

<b>Gesamtenergieverbrauch:</b>	9W
<b>Stromversorgung:</b>	48V
<b>Betriebstemperatur:</b>	-10°C ~ 35°C
<b>Steuerungsprotokoll:</b>	0-10V / Dali / Casambi
<b>Schutzklasse:</b>	Klasse III

## Lichtquelle

<b>LED-Typ:</b>	SMD
<b>CCT:</b>	2700K/3000K/4000K
<b>CRI:</b>	Ra>90
<b>Strahlungswinkel:</b>	7° /15° /24° /38° /10°x35° /Honeycomb
<b>UGR:</b>	<16

## Gehäuse

<b>Leuchtkörperdurchmesser:</b>	50mm
<b>Material:</b>	Aluminium, Kunststoff
<b>Gewicht:</b>	255.6g

## Garantie

<b>Zeitraum:</b>	5 Jahre Garantie
------------------	------------------

## Lichtleistung

Die Leuchtkraft wurde mit der Originaloptik (7 °) gemessen.

Winkel \ CCT	2700K	3000K	4000K
7°	450lm	500lm	550lm

## Nomenclature

\*Gültiges Modell: M40409xx90xxxx (xx: dynamische Codes)

Produktcode	Systemleistung	CCT	CRI	Strahlungswinkel	Antrieb/ Steuerung	Seriennummer
M404	09(09W)	27(2700K)	90(90)	07(7°)	N(Non-Dim)	01(Black)
M413		30(4000K)		15(15°)	A(0-10V dim)	02(White)
		40(4000K)		24(24°)	D(Dali dim)	
				38(38°)		
				X1(10°x35°)		
				HC(Honeycomb)		
				TW(Tunable)		
				18(18°)		
				24(24°)		
				38(38°)		

# Cubo Niedervolt-Magnetschienenensystem



## Elektrisches System

<b>Gesamtenergieverbrauch:</b>	9W
<b>Stromversorgung:</b>	48V
<b>Betriebstemperatur:</b>	-10°C ~ 35°C
<b>Steuerungsprotokoll:</b>	0-10V / Dali / Casambi
<b>Schutzklasse:</b>	Klasse III

## Lichtquelle

<b>LED-Typ:</b>	SMD
<b>CCT:</b>	2700K/3000K/4000K
<b>CRI:</b>	Ra>90
<b>Strahlungswinkel:</b>	7°/15°/24°/38°/10°x35°/Honeycomb
<b>UGR:</b>	<16

- Weiß  
● Schwarz

## Merkmale

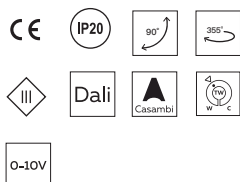

## Maße

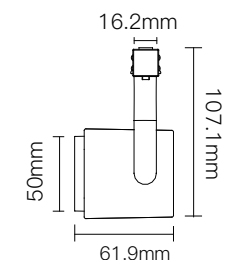
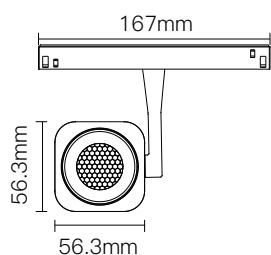

## Gehäuse

<b>Leuchtkörperdurchmesser:</b>	56,3mm x 56,3mm
<b>Material:</b>	Aluminium, Kunststoff
<b>Gewicht:</b>	304.6g

## Garantie

<b>Zeitraum:</b>	5 Jahre Garantie
------------------	------------------

## Lichtleistung

Die Leuchtkraft wurde mit der Originaloptik (7 °) gemessen.

Winkel \ CCT	2700K	3000K	4000K
7°	405lm	450lm	500lm

## Nomenklatur

\*Gültiges Modell: M40510xx90xxxx (xx: xx: dynamische Codes)

Produktcode	Systemleistung	CCT	CRI	Strahlungswinkel	Antrieb/Steuerung	Seriennummer	
M405	09(9W)	27(2700K)	90(90)	07(7°)	N(Non-Dim)	01(Black)	
		30(3000K)		15°(15°)	A(0-10V dim)	02(White)	
		40(4000K)		24°(24°)	D(Dali dim)		
				38°(38°)			
				X1(10°x35°)			
				HC(Honeycomb)			
				TW(Tunable)	18(18°)		
					24(24°)		
					38(38°)		

# Dabo Niedervolt-Magnetschienensystem



## Elektrisches System

<b>Gesamtenergieverbrauch:</b>	10W
<b>Stromversorgung:</b>	48V
<b>Betriebstemperatur:</b>	-10°C ~ 35°C
<b>Steuerungsprotokoll:</b>	0-10V / Dali / Casambi
<b>Schutzklasse:</b>	Klasse III

## Lichtquelle

<b>LED-Typ:</b>	SMD
<b>CCT:</b>	2700K/3000K/4000K
<b>CRI:</b>	Ra>90
<b>Strahlungswinkel:</b>	10°
<b>UGR:</b>	<16

- Weiß  
● Schwarz

## Merkmale



## Maße

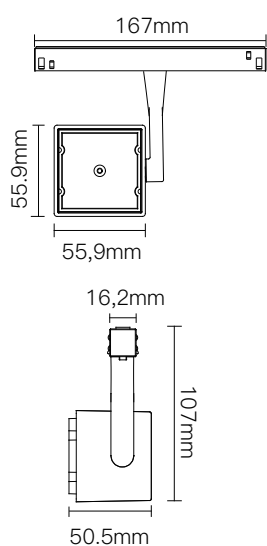

## Gehäuse

<b>Leuchtkörperdurchmesser:</b>	55,9mm x 55,9mm
<b>Material:</b>	Aluminium, Kunststoff
<b>Gewicht:</b>	266g

## Garantie

<b>Zeitraum:</b>	5 Jahre Garantie
------------------	------------------

## Lichtleistung

Winkel \ CCT	2700K	3000K	4000K
10°	504lm	560lm	616lm

## Nomenklatur

\*Gültiges Modell: M40610xx90xxxx (xx: dynamische Codes)

Produktcode	Systemleistung	CCT	CRI	Strahlungswinkel	Antrieb/Steuerung	Seriennummer
M406	10(10W)	27(2700K)	90(90)	10(10°)	N(Non-Dim)	01(Black)
		30(3000K)			A(0-10V dim)	02(White)
		40(4000K)			D(Dali dim)	

# Pixy Niedervolt-Magnetschienenensystem



## Elektrisches System

<b>Gesamtenergieverbrauch:</b>	7W
<b>Stromversorgung:</b>	48V
<b>Betriebstemperatur:</b>	-10°C ~ 35°C
<b>Steuerungsprotokoll:</b>	0-10V / Dali / Casambi
<b>Schutzklasse:</b>	Klasse III

## Lichtquelle

<b>LED-Typ:</b>	COB
<b>CCT:</b>	2700K/3000K/4000K
<b>CRI:</b>	Ra>90
<b>Strahlungswinkel:</b>	Wash wall
<b>UGR:</b>	<19

- Weiß  
● Schwarz

## Merkmale



## Maße

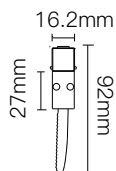
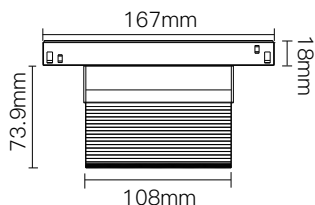

## Gehäuse

<b>Leuchtkörperdurchmesser:</b>	108mm x 73,9mm
<b>Material:</b>	Aluminium, Kunststoff
<b>Gewicht:</b>	178.8g

## Garantie

<b>Zeitraum:</b>	5 Jahre Garantie
------------------	------------------

## Lichtleistung

Winkel \ CCT	2700K	3000K	4000K
Wall wash	504lm	560lm	610lm

## Nomenklatur

\*Gültiges Modell: M40407xx90xxxx (xx: dynamische Codes)

Produktcode	Systemleistung	CCT	CRI	Strahlungswinkel	Antrieb/ Steuerung	Seriennummer
M401	07(7W)	27(2700K)	90(90)	WW(Wall Wsah)	N(Non-Dim)	01(Black)
		30(3000K)			A(0-10V dim)	02(White)
		40(4000K)			D(Dali dim)	

# Casa Niedervolt-Magnetschienensystem



## Elektrisches System

<b>Total power consumption:</b>	12W
<b>Power input:</b>	48V
<b>Operating temperature:</b>	-10°C ~ 35°C
<b>Dimming option:</b>	0-10V / Dali / Casambi
<b>Insulation class:</b>	Klasse III

## Lichtquelle

<b>LED-Typ:</b>	SMD
<b>CCT:</b>	2700K/3000K/4000K
<b>CRI:</b>	Ra>90
<b>Strahlungswinkel:</b>	Asymmetric (30°)
<b>UGR:</b>	<19

- Weiß  
● Schwarz

## Merkmale



## Maße

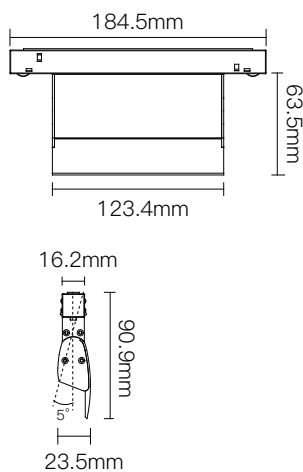

## Gehäuse

<b>Leuchtkörperdurchmesser:</b>	63,5mm x 123,4mm
<b>Material:</b>	Aluminium, Kunststoff
<b>Gewicht:</b>	212.5g

## Garantie

<b>Zeitraum:</b>	5 Jahre Garantie
------------------	------------------

## Lichtleistung

Winkel \ CCT	2700K	3000K	4000K
30°	468lm	520lm	570lm

## Nomenklatur

\*Gültiges Modell: M40213xx90xxxx (xx: dynamische Codes)

Produktcode	Systemleistung	CCT	CRI	Strahlungswinkel	Antrieb/ Steuerung	Seriennummer
M402	12(12W)	27(2700K) 30(3000K) 40(4000K)	90(90)	30(30°)	N(Non-Dim) A(0-10V dim) D(Dali dim)	01(Black) 02(White)



# Bande Niedervolt-Magnetschienensystem



## Elektrisches System

<b>Gesamtenergieverbrauch:</b>	6W / 10W / 20W
<b>Stromversorgung:</b>	48V
<b>Betriebstemperatur:</b>	-10°C ~ 35°C
<b>Steuerprotokoll:</b>	0-10V / Dali / Casambi
<b>Schutzklasse:</b>	Klasse III

## Lichtquelle

<b>LED-Typ:</b>	SMD
<b>CCT:</b>	2700K/3000K/4000K
<b>CRI:</b>	Ra>90
<b>Strahlungswinkel:</b>	38°
<b>UGR:</b>	<16

○ Weiß

● Schwarz

## Merkmale



## Maße

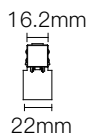
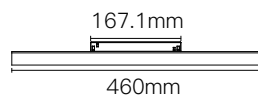
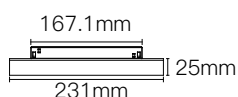
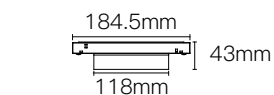

## Gehäuse

<b>Leuchtkörperdurchmesser:</b>	118mm x 22mm / 231mm x 22mm / 460mm x 22mm
<b>Material:</b>	Aluminium, Kunststoff
<b>Gewicht:</b>	110.3g / 178.2g / 316.5g

## Garantie

<b>Zeitraum:</b>	5 Jahre Garantie
------------------	------------------

## Lichtleistung

Winkel \ CCT	2700K	3000K	4000K
38° (6W)	315lm	350lm	385lm
38° (11W)	450lm	500lm	550lm
38° (20W)	990lm	1100lm	1210lm

## Nomenklatur

\*Gültiges Modell: M410xxxx90xxxx (xx: dynamische Codes)

Produktcode	Systemleistung	CCT	CRI	Strahlungswinkel	Antrieb/Steuerung	Seriennummer
M410	06(6W)	27(2700K)	90(90)	38(38°)	N(Non-Dim)	01(Black)
	11(11W)	30(3000K)			A(0-10V dim)	02(White)
	20(20W)	40(4000K)			D(Dali dim)	

# Bande Diffuser Niedervolt-Magnetschienenensystem



- Weiß  
● Schwarz

## Merkmale

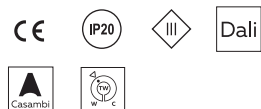

## Maße

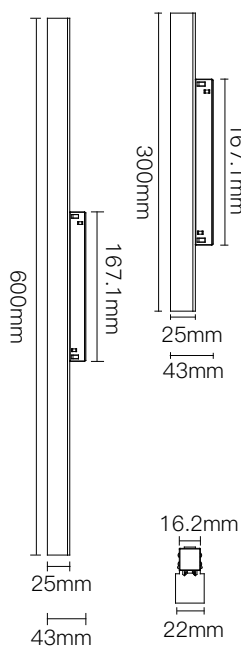

## Elektrisches System

<b>Gesamtenergieverbrauch:</b>	11W / 20W
<b>Stromversorgung:</b>	48V
<b>Betriebstemperatur:</b>	-10°C ~ 35°C
<b>Steuerungsprotokoll:</b>	0-10V / Dali / Casambi
<b>Schutzklasse:</b>	Klasse III

## Lichtquelle

<b>LED-Typ:</b>	SMD
<b>CCT:</b>	2700K/3000K/4000K
<b>CRI:</b>	Ra>90
<b>Strahlungswinkel:</b>	Flood
<b>UGR:</b>	<16

## Gehäuse

<b>Leuchtkörperdurchmesser:</b>	300mm x 22mm / 600mm x 22mm
<b>Material:</b>	Aluminium, Kunststoff
<b>Gewicht:</b>	199.3g /313.8g

## Gehäuse

<b>Zeitraum:</b>	5 Jahre Garantie
------------------	------------------

## Lichtleistung

Winkel \ CCT	2700K	3000K	4000K
Flood (11W)	459lm	510lm	560lm
Flood (20W)	945lm	1050lm	1155lm
Blendfrei (11W)	322lm	357lm	392lm
Blendfrei (20W)	662lm	735lm	809lm

## Nomenklatur

\*Gültiges Modell: M411xxx90xxxx (xx: dynamische Codes)

Produktcode	Systemleistung	CCT	CRI	Strahlungswinkel	Antrieb/Steuerung	Seriennummer
M411	11(11W)	27(2700K)	90(90)	FD(Flood)	N(Non-Dim)	01(Black)
	20(20W)	30(3000K)		GW(Blendfrei)	A(0-10V dim)	02(White)
		40(4000K)			D(Dali dim)	
		TW(Tunable)		18(18°)		
				24(24°)		
				38(38°)		

# Ami Pendant Niedervolt-Magnetschienensystem



- Weiß  
● Schwarz

## Merkmale



## Maße

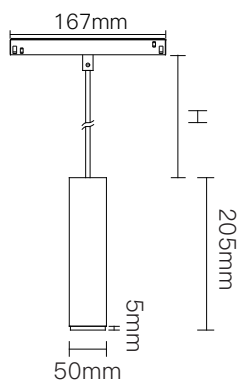

## Elektrisches System

<b>Gesamtenergieverbrauch:</b>	9W
<b>Stromversorgung:</b>	48V
<b>Betriebstemperatur:</b>	-10°C ~ 35°C
<b>Steuerungsprotokoll:</b>	0-10V / Dali / Casambi
<b>Schutzklasse:</b>	Klasse III

## Lichtquelle

<b>LED-Typ:</b>	SMD
<b>CCT:</b>	2700K/3000K/4000K
<b>CRI:</b>	Ra>90
<b>Strahlungswinkel:</b>	7° /15° /24° /38° /10°x35° /Honeycomb
<b>UGR:</b>	<19

## Gehäuse

<b>Leuchtkörperdurchmesser:</b>	50mm
<b>Material:</b>	Aluminium, Kunststoff
<b>Gewicht:</b>	425g

## Garantie

<b>Zeitraum:</b>	5 Jahre Garantie
------------------	------------------

## Lichtleistung

Die Leuchtkraft wurde mit der Originaloptik (7 °) gemessen.

Winkel \ CCT	2700K	3000K	4000K
7°	369lm	410lm	450lm

## Nomenklatur

\*Gültiges Modell: M40713xx90xxxx (xx: dynamische Codes)

Produktcode	Systemleistung	CCT	CRI	Strahlungswinkel	Antrieb/ Steuerung	Seriennummer
M407	09(9W)	27(2700K)	90(90)	07(7°)	N(Non-Dim)	01(Black)
		30(3000K)		15(15°)		
		40(4000K)		24(24°)	D(Dali dim)	
				38(38°)		
				X1(10°x35°)		
				HC(Honeycomb)		
				TW(Tunable)	18(18°)	
					24(24°)	
					38(38°)	

# Canos Niedervolt-Magnetschienenensystem



## Elektrisches System

<b>Gesamtenergieverbrauch:</b>	7W
<b>Stromversorgung:</b>	48V
<b>Betriebstemperatur:</b>	-10°C ~ 35°C
<b>Steuerprotokoll:</b>	0-10V / Dali / Casambi
<b>Schutzklasse:</b>	Klasse III

## Lichtquelle

<b>LED-Typ:</b>	COB
<b>CCT:</b>	2700K/3000K/4000K
<b>CRI:</b>	Ra>90
<b>Strahlungswinkel:</b>	15° /24° /36°
<b>UGR:</b>	<16

- Weiß  
● Schwarz

## Merkmale

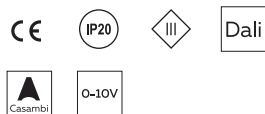

## Gehäuse

<b>Leuchtkörperdurchmesser:</b>	44,3mm
<b>Material:</b>	Aluminium, Kunststoff
<b>Gewicht:</b>	173.9g

## Maße

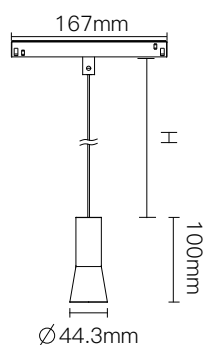

## Garantie

<b>Zeitraum:</b>	5 Jahre Garantie
------------------	------------------

## Lichtleistung

Winkel \ CCT	2700K	3000K	4000K
15°	324lm	360lm	396lm
24°	360lm	400lm	440lm
38°	342lm	380lm	420lm

## Nomenklatur

\*Gültiges Modell: M40807xx90xxxx (xx: dynamische Codes)

Produktcode	Systemleistung	CCT	CRI	Strahlungswinkel	Antrieb/Steuerung	Seriennummer
M408	07(7W)	27(2700K)	90(90)	15(15°)	N(Non-Dim)	01(Black)
		30(3000K)		24(24°)	A(0-10V dim)	02(White)
		40(4000K)		36(36°)	D(Dali dim)	

# Navia Niedervolt-Magnetschienensystem



- Weiß
- Schwarz

## Merkmale

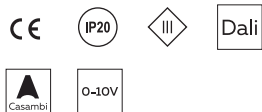

## Maße

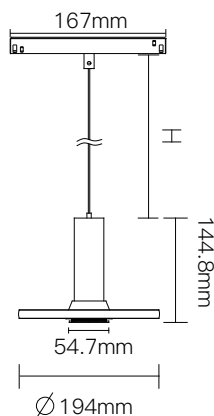

## Elektrisches System

<b>Gesamtenergieverbrauch:</b>	7W
<b>Stromversorgung:</b>	48V
<b>Betriebstemperatur:</b>	-10°C ~ 35°C
<b>Steuerprotokoll:</b>	0-10V / Dali / Casambi
<b>Schutzklasse:</b>	Klasse III

## Lichtquelle

<b>LED-Typ:</b>	COB
<b>CCT:</b>	2700K/3000K/4000K
<b>CRI:</b>	Ra>90
<b>Strahlungswinkel:</b>	24°
<b>UGR:</b>	<16

## Gehäuse

<b>Leuchtkörperdurchmesser:</b>	194mm
<b>Material:</b>	Aluminium, Kunststoff
<b>Gewicht:</b>	430.4g

## Garantie

<b>Zeitraum:</b>	5 Jahre Garantie
------------------	------------------

## Lichtleistung

Winkel \ CCT	2700K	3000K	4000K
24°	360lm	400lm	440lm

## Nomenklatur

\*Gültiges Modell: M40913xx90xxxx (xx: dynamische Codes)

Produktcode	Systemleistung	CCT	CRI	Strahlungswinkel	Antrieb/ Steuerung	Seriennummer
M409	07(7W)	27(2700K) 30(3000K) 40(4000K)	90(90)	24(24°)	N(Non-Dim) A(0-10V dim) D(Dali dim)	01(Black) 02(White)

# Mona

## Niedervolt-Magnetschienensystem



- Weiß  
● Schwarz

### Merkmale



### Maße

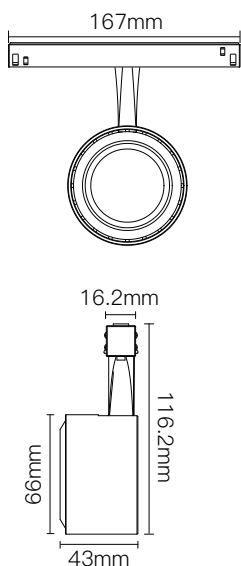

### Elektrisches System

<b>Gesamtenergieverbrauch:</b>	12W
<b>Stromversorgung:</b>	48V
<b>Betriebstemperatur:</b>	-10°C ~ 35°C
<b>Steuerprotokoll:</b>	0-10V / Dali / Casambi
<b>Schutzklasse:</b>	Klasse III

### Lichtquelle

<b>LED-Typ:</b>	COB
<b>CCT:</b>	2700K/3000K/4000K
<b>CRI:</b>	Ra>92
<b>Strahlungswinkel:</b>	17°/30°
<b>UGR:</b>	<16

### Gehäuse

<b>Leuchtkörperdurchmesser:</b>	66mm
<b>Material:</b>	Aluminium, Kunststoff
<b>Gewicht:</b>	230g

### Garantie

<b>Zeitraum:</b>	5 Jahre Garantie
------------------	------------------

### Lichtleistung

Winkel \ CCT	2700K	3000K	4000K
17°	620lm	650lm	689lm
30°	620lm	650lm	689lm

### Nomenklatur

\*Gültiges Modell: M41412xx90xxxx (xx: dynamische Codes)

Produktcode	Systemleistung	CCT	CRI	Strahlungswinkel	Antrieb/Steuerung	Seriennummer
M414	12(12W)	27(2700K)	90(90)	17(17°)	N(Non-Dim)	01(Schwarz)
		30(3000K)		30(30°)	A(0-10V dim)	02(Weiß)
		40(4000K)			D(DT6)	
					E(DT8)	

# Marmor

## Niedervolt-Magnetschienensystem



- Weiß  
● Schwarz

### Merkmale



### Maße

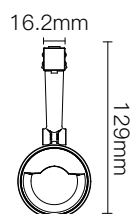
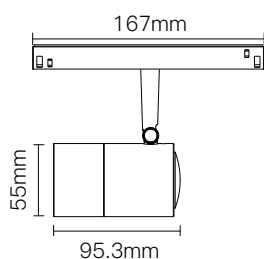

### Elektrisches System

<b>Gesamtenergieverbrauch:</b>	12W
<b>Stromversorgung:</b>	48V
<b>Betriebstemperatur:</b>	-10°C ~ 35°C
<b>Steuerungsprotokoll:</b>	0-10V / Dali / Casambi
<b>Schutzklasse:</b>	Klasse III

### Lichtquelle

<b>LED-Typ:</b>	COB
<b>CCT:</b>	2700K/3000K/4000K
<b>CRI:</b>	Ra>92
<b>Strahlungswinkel:</b>	Wallwash
<b>UGR:</b>	NA

### Gehäuse

<b>Leuchtkörperdurchmesser:</b>	55mm
<b>Material:</b>	Aluminium, Kunststoff
<b>Gewicht:</b>	293g

### Garantie

<b>Zeitraum:</b>	5 Jahre Garantie
------------------	------------------

### Lichtleistung

Winkel \ CCT	2700K	3000K	4000K
Wallwash	515lm	541lm	573lm

### Nomenklatur

\*Gültiges Modell: M41512xx90xxxx (xx: dynamische Codes)

Produktcode	Systemleistung	CCT	CRI	Strahlungswinkel	Antrieb/Steuerung	Seriennummer
M415	12(12W)	27(2700K) 30(3000K) 40(4000K)	90(90)	WW(Wallwash)	N(Non-Dim) A(0-10V dim) D(DT6) E(DT8)	01(Schwarz) 02(Weiß)

# Mika

## Niedervolt-Magnetschienensystem



● Schwarz

### Merkmale



### Maße

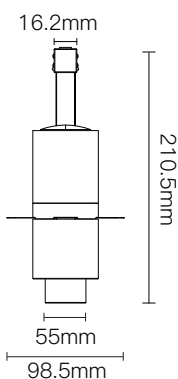
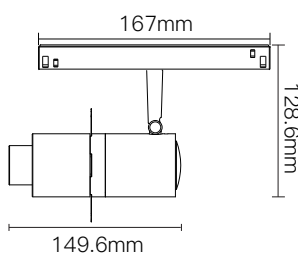

### Elektrisches System

<b>Gesamtenergieverbrauch:</b>	12W
<b>Stromversorgung:</b>	48V
<b>Betriebstemperatur:</b>	-10°C ~ 35°C
<b>Steuerprotokoll:</b>	0-10V / Dali / Casambi
<b>Schutzklasse:</b>	Klasse III

### Lichtquelle

<b>LED-Typ:</b>	COB
<b>CCT:</b>	2700K/3000K/4000K
<b>CRI:</b>	Ra>90
<b>Strahlungswinkel:</b>	Beam shaper
<b>UGR:</b>	<10

### Gehäuse

<b>Leuchtkörperdurchmesser:</b>	55mm
<b>Material:</b>	Aluminium, Kunststoff
<b>Gewicht:</b>	431g

### Garantie

<b>Zeitraum:</b>	5 Jahre Garantie
------------------	------------------

### Lichtleistung

Winkel \ CCT	2700K	3000K	4000K
Beam shaper	300lm	300lm	315lm

### Nomenklatur

\*Gültiges Modell: M41612xx90xxxx (xx: dynamische Codes)

Produktcode	Systemleistung	CCT	CRI	Strahlungswinkel	Antrieb/Steuerung	Seriennummer
M416	12(12W)	27(2700K) 30(3000K) 40(4000K)	90(90)	SP(Shaper)	N(Non-Dim) A(0-10V dim) D(DT6) E(DT8)	01(Schwarz)



# Polo\_50

## Niedervolt-Magnetschienensystem



- Weiß  
● Schwarz

### Merkmale



### Maße

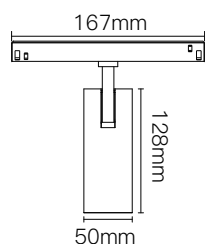

16.2mm

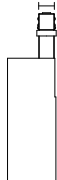

### Elektrisches System

<b>Gesamtenergieverbrauch:</b>	15W
<b>Stromversorgung:</b>	48V
<b>Betriebstemperatur:</b>	-10°C ~ 35°C
<b>Steuerprotokoll:</b>	0-10V / Dali / Casambi
<b>Schutzklasse:</b>	Klasse III

### Lichtquelle

<b>LED-Typ:</b>	COB
<b>CCT:</b>	2700K/3000K/4000K
<b>CRI:</b>	Ra>92
<b>Strahlungswinkel:</b>	20°/38°/55°
<b>UGR:</b>	<19

### Gehäuse

<b>Leuchtkörperdurchmesser:</b>	50mm
<b>Material:</b>	Aluminium, Kunststoff
<b>Gewicht:</b>	350g

### Garantie

<b>Zeitraum:</b>	5 Jahre Garantie
------------------	------------------

### Lichtleistung

Winkel \ CCT	2700K	3000K	4000K
20°	1189lm	1248lm	1323lm
38°	1215lm	1276lm	1353lm
55°	1079lm	1133lm	1200lm

### Nomenklatur

\*Gültiges Modell: M41715xx90xxxx (xx: dynamische Codes)

Produktcode	Systemleistung	CCT	CRI	Strahlungswinkel	Antrieb/Steuerung	Seriennummer
M417	15(15W)	27(2700K)	90(90)	20(20°)	N(Non-Dim)	01(Schwarz)
		30(3000K)		38(38°)	A(0-10V dim)	02(Weiß)
		40(4000K)		55(55°)	D(DT6)	
					E(DT8)	

# Polo\_70

## Niedervolt-Magnetschienensystem



- Weiß  
● Schwarz

### Merkmale



### Maße

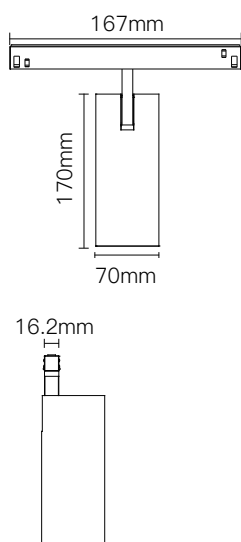

### Elektrisches System

<b>Gesamtenergieverbrauch:</b>	25W
<b>Stromversorgung:</b>	48V
<b>Betriebstemperatur:</b>	-10°C ~ 35°C
<b>Steuerprotokoll:</b>	0-10V / Dali / Casambi
<b>Schutzklasse:</b>	Klasse III

### Lichtquelle

<b>LED-Typ:</b>	COB
<b>CCT:</b>	2700K/3000K/4000K
<b>CRI:</b>	Ra>92
<b>Strahlungswinkel:</b>	15°/24°/36°
<b>UGR:</b>	<19

### Gehäuse

<b>Leuchtkörperdurchmesser:</b>	70mm
<b>Material:</b>	Aluminium, Kunststoff
<b>Gewicht:</b>	580g

### Garantie

<b>Zeitraum:</b>	5 Jahre Garantie
------------------	------------------

### Lichtleistung

Winkel \ CCT	2700K	3000K	4000K
15°	1869lm	1962lm	2080lm
24°	1954lm	2052lm	2175lm
36°	1914lm	2010lm	2131lm

### Nomenklatur

\*Gültiges Modell: M41825xx90xxxx (xx: dynamische Codes)

Produktcode	Systemleistung	CCT	CRI	Strahlungswinkel	Antrieb/Steuerung	Seriennummer
M418	25(25W)	27(2700K)	90(90)	15(15°)	N(Non-Dim)	01(Schwarz)
		30(3000K)		24(24°)	A(0-10V dim)	02(Weiß)
		40(4000K)		36(36°)	D(DT6)	
					E(DT8)	

# Ami-Rund

## Einbauleuchte

### Zoom



- Weiß  
● Schwarz

### Merkmale



### Maße

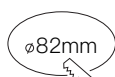
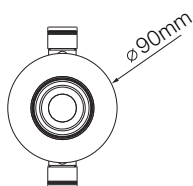
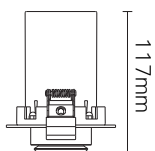

### Elektrisches System

<b>Gesamtenergieverbrauch:</b>	10W
<b>Stromversorgung:</b>	220Vac
<b>Betriebstemperatur:</b>	-10°C ~ 35°C
<b>Leistungsfaktor:</b>	>0.95
<b>Steuerungsprotokoll:</b>	0-10V / Dali / Casambi
<b>Schutzklasse:</b>	Klasse III

### Lichtquelle

<b>LED-Typ:</b>	COB
<b>CCT:</b>	2700K/3000K/4000K
<b>CRI:</b>	Ra>90
<b>Strahlungswinkel:</b>	18°-45°
<b>UGR:</b>	<16

### Gehäuse

<b>Maße:</b>	90mm x 117mm
<b>Material:</b>	Aluminium, Kunststoff
<b>Gewicht:</b>	445g

### Garantie

<b>Zeitraum:</b>	5 Jahre Garantie
------------------	------------------

### Lichtleistung

Winkel \ CCT	2700K	3000K	4000K
18°-45°	290lm	320lm	350lm

### Nomenklatur

\*Gültiges Modell: M20110xx90xxxx (xx: dynamische Codes)

Produktcode	Systemleistung	CCT	CRI	Strahlungswinkel	Antrieb/ Steuerung	Seriennummer
M201	10(10W)	27(2700K)	90(90)	Z2(18°-45°)	N(Non-Dim)	01(Black)
		30(3000K)			A(0-10V dim)	02(White)
		40(4000K)			D(Dali dim)	
		TW(Tunable)				

# Ami-Rechteck Einbauleuchte

## Zoom



- Weiß  
● Schwarz

### Merkmale



### Maße

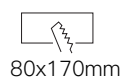
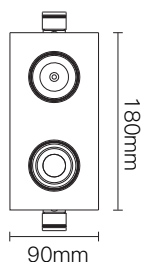
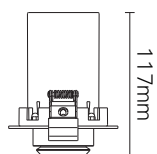

### Elektrisches System

<b>Gesamtenergieverbrauch:</b>	10W*2
<b>Stromversorgung:</b>	220Vac
<b>Betriebstemperatur:</b>	-10°C ~ 35°C
<b>Leistungsfaktor:</b>	>0.95
<b>Steuerungsprotokoll:</b>	0-10V / Dali /Casambi
<b>Schutzklasse:</b>	Klasse III

### Lichtquelle

<b>LED-Typ:</b>	COB
<b>CCT:</b>	2700K/3000K/4000K
<b>CRI:</b>	Ra>90
<b>Strahlungswinkel:</b>	18°-45°
<b>UGR:</b>	<16

### Gehäuse

<b>Maße:</b>	180mm x 90mm x 117mm
<b>Material:</b>	Aluminum
<b>Gewicht:</b>	885g

### Garantie

<b>Zeitraum:</b>	5 Jahre Garantie
------------------	------------------

### Lichtleistung

Winkel \ CCT	2700K	3000K	4000K
18°-45°	290lm*2	320lm*2	350lm*2

### Nomenklatur

\*Gültiges Modell: M20220xx90xxxx (xx: dynamische Codes)

Produktcode	Systemleistung	CCT	CRI	Strahlungswinkel	Antrieb/ Steuerung	Seriennummer
M202	20(20W)	27(2700K) 30(3000K) 40(4000K)	90(90)	Z2(18°-45°)	N(Non-Dim) A(0-10V dim) D(Dali dim)	01(Black) 02(White)
		TW(Tunable)				

# Ami-Quadrat

## Einbauleuchte

### Zoom



- Weiß  
● Schwarz

### Merkmale



### Maße

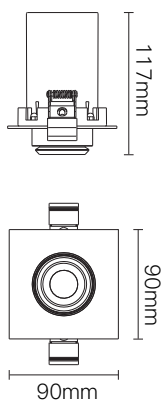

ø82mm

### Elektrisches System

<b>Gesamtenergieverbrauch:</b>	10W
<b>Stromversorgung:</b>	220Vac
<b>Betriebstemperatur:</b>	-10°C ~ 35°C
<b>Leistungsfaktor:</b>	>0.95
<b>Steuerungsprotokoll:</b>	0-10V / Dali / Casambi
<b>Schutzklasse:</b>	Klasse III

### Lichtquelle

<b>LED-Typ:</b>	COB
<b>CCT:</b>	2700K/3000K/4000K
<b>CRI:</b>	Ra>90
<b>Strahlungswinkel:</b>	18°-45°
<b>UGR:</b>	<16

### Gehäuse

<b>Maße:</b>	90mm x 90mm x 117mm
<b>Material:</b>	Aluminum
<b>Gewicht:</b>	420g

### Garantie

<b>Zeitraum:</b>	5 Jahre Garantie
------------------	------------------

### Lichtleistung

Winkel \ CCT	2700K	3000K	4000K
18°-45°	290lm	320lm	350lm

### Nomenklatur

\*Gültiges Modell: M20310xx90xxxx (xx: dynamische Codes)

Produktcode	Systemleistung	CCT	CRI	Strahlungswinkel	Antrieb/ Steuerung	Seriennummer
M203	10(10W)	27(2700K) 30(3000K) 40(4000K)	90(90)	Z2(18°-45°)	N(Non-Dim) A(0-10V dim) D(Dali dim)	01(Black) 02(White)
		TW(Tunable)				

# Ami-Rund

## Einbauleuchte

### Filter



- Weiß  
● Schwarz

### Merkmale



### Maße

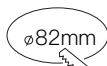
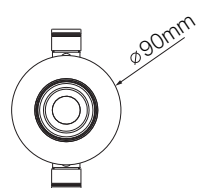
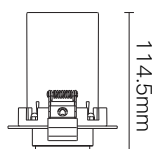

### Elektrisches System

<b>Gesamtenergieverbrauch:</b>	10W
<b>Stromversorgung:</b>	220Vac
<b>Betriebstemperatur:</b>	-10°C ~ 35°C
<b>Leistungsfaktor:</b>	>0.95
<b>Steuerungsprotokoll:</b>	0-10V / Dali / Casambi
<b>Schutzklasse:</b>	Klasse III

### Lichtquelle

<b>LED-Typ:</b>	SMD
<b>CCT:</b>	2700K/3000K/4000K
<b>CRI:</b>	Ra>90
<b>Strahlungswinkel:</b>	15° /24° /38° /10°x35° /Honeycomb
<b>UGR:</b>	<16

### Gehäuse

<b>Maße:</b>	90mm x 114,5mm
<b>Material:</b>	Aluminum
<b>Gewicht:</b>	445g

### Garantie

**Zeitraum:** 5 Jahre Garantie

**Lichtleistung** \*Die Leuchtkraft wurde mit der Originaloptik (7 °) gemessen.

Winkel \ CCT	2700K	3000K	4000K
7°	370lm	410lm	450lm

### Nomenklatur

\*Gültiges Modell: M20410xx90xxxx (xx: dynamische Codes)

Produktcode	Systemleistung	CCT	CRI	Strahlungswinkel	Antrieb/ Steuerung	Seriennummer
M204	10(10W)	27(2700K)	90(90)	07(7°)	N(Non-Dim)	01(Black)
		30(3000K)		15°(15°)	A(0-10V dim)	02(White)
		40(4000K)		24°(24°)	D(Dali dim)	
				38°(38°)		
				X1(10°x35°)		
				HC(Honeycomb)		
				TW(Tunable)		
			18(18°)			
			38(38°)			

# Ami-Rechteck Einbauleuchte

## Filter



- Weiß  
● Schwarz

## Merkmale



## Maße

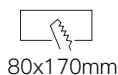
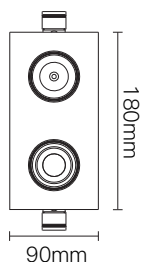
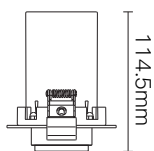

## Elektrisches System

<b>Gesamtenergieverbrauch:</b>	10W*2
<b>Stromversorgung:</b>	220Vac
<b>Betriebstemperatur:</b>	-10°C ~ 35°C
<b>Leistungsfaktor:</b>	>0.95
<b>Steuerungsprotokoll:</b>	0-10V / Dali / Casambi
<b>Schutzklasse:</b>	Klasse III

## Lichtquelle

<b>LED-Typ:</b>	SMD
<b>CCT:</b>	2700K/3000K/4000K
<b>CRI:</b>	Ra>90
<b>Strahlungswinkel:</b>	15° /24° /38° /10°x35° /Honeycomb
<b>UGR:</b>	<16

## Gehäuse

<b>Maße:</b>	180mm x 90mm x 114,5mm
<b>Material:</b>	Aluminum
<b>Gewicht:</b>	885g

## Garantie

**Zeitraum:** 5 Jahre Garantie

**Lichtleistung** \*Die Leuchtkraft wurde mit der Originaloptik (7 °) gemessen.

CCT Winkel	2700K	3000K	4000K
7°	370lm*2	410lm*2	450lm*2

## Nomenklatur

\*Gültiges Modell: M20520xx90xxxx (xx: dynamische Codes)

Produktcode	Systemleistung	CCT	CRI	Strahlungswinkel	Antrieb/ Steuerung	Seriennummer
M205	20(20W)	27(2700K)	90(90)	07(7°)	N(Non-Dim)	01(Black)
		30(3000K)		15°(15°)	A(0-10V dim)	02(White)
		40(4000K)		24°(24°)	D(Dali dim)	
				38°(38°)		
				X1(10°x35°)		
			HC(Honeycomb)			
		TW(Tunable)		18(18°)		
				38(38°)		

# Ami-Quadrat

## Einbauleuchte

### Filter



- Weiß  
● Schwarz

### Merkmale



### Maße

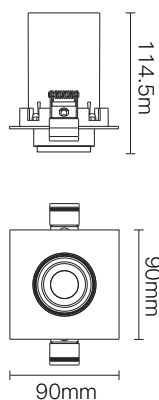

ø82mm

### Elektrisches System

<b>Gesamtenergieverbrauch:</b>	10W
<b>Stromversorgung:</b>	220Vac
<b>Betriebstemperatur:</b>	-10°C ~ 35°C
<b>Leistungsfaktor:</b>	>0.95
<b>Steuerungsprotokoll:</b>	0-10V / Dali / Casambi
<b>Schutzklasse:</b>	Klasse III

### Lichtquelle

<b>LED-Typ:</b>	SMD
<b>CCT:</b>	2700K/3000K/4000K
<b>CRI:</b>	Ra>90
<b>Strahlungswinkel:</b>	15° /24° /38° /10°x35° /Honeycomb
<b>UGR:</b>	<16

### Gehäuse

<b>Maße:</b>	90mm x 90mm x 114,5mm
<b>Material:</b>	Aluminum
<b>Gewicht:</b>	420g

### Garantie

**Zeitraum:** 5 Jahre Garantie

**Lichtleistung** \* Die Leuchtkraft wurde mit der Originaloptik (7°) gemessen.

Winkel \ CCT	2700K	3000K	4000K
7°	370lm	410lm	450lm

### Nomenklatur

\*Gültiges Modell: M20610xx90xxxx (xx: dynamische Codes)

Produktcode	Systemleistung	CCT	CRI	Strahlungswinkel	Antrieb/ Steuerung	Seriennummer
M206	10(10W)	27(2700K)	90(90)	07(7°)	N(Non-Dim)	01(Black)
		30(3000K)		15°(15°)	A(0-10V dim)	02(White)
		40(4000K)		24°(24°)	D(Dali dim)	
				38°(38°)		
				X1(10°x35°)		
				HC(Honeycomb)		
		TW(Tunable)		18(18°)		
				38(38°)		



# Daten zur Beleuchtungsstärke

## Ami-Zoom

10W



15°

h(m)	E(lx)	S_B(sq.m)
1	2212.77	0.1
2	553.19	0.2
3	245.86	0.5
4	138.30	0.9
5	88.51	1.3

45°

h(m)	E(lx)	S_B(sq.m)
1	630.69	0.6
2	157.67	2.3
3	70.08	5.1
4	39.42	9.0
5	25.23	14.1

## Ami-Filter

9W



10°

h(m)	E(lx)	S_B(sq.m)
1	6810.11	0.025
2	1702.53	0.1
3	756.68	0.2
4	425.63	0.4
5	272.40	0.7

## Cubo

9W



10°

h(m)	E(lx)	S_B(sq.m)
1	6525.81	0.025
2	1631.45	0.1
3	725.09	0.3
4	407.86	0.4
5	261.03	0.7

## Dabo

10W



14°

h(m)	E(lx)	S_B(sq.m)
1	6195.39	0.05
2	1548.85	0.2
3	688.38	0.4
4	387.21	0.7
5	247.82	1.2

## Casa

12W



30°

h(m)	E(lx)	S_B(sq.m)
1	2310.93	0.2
2	577.73	0.9
3	256.77	2.1
4	144.43	3.8
5	92.44	5.9

## Bande

6W



38°

h(m)	E(lx)	S_B(sq.m)
1	707.40	0.4
2	176.85	1.5
3	78.60	3.4
4	44.21	6.1
5	28.30	9.5

## Bande

11W



38°

h(m)	E(lx)	S_B(sq.m)
1	1285.18	0.2
2	321.30	0.9
3	142.80	2.0
4	80.32	3.6
5	51.41	5.6

## Bande

20W



38°

h(m)	E(lx)	S_B(sq.m)
1	2744.10	0.2
2	686.03	0.8
3	304.90	1.8
4	171.51	3.3
5	109.76	5.1

## Bande diffuser

11W



Flood

h(m)	E(lx)	S_B(sq.m)
1	241.01	5.0
2	60.25	19.9
3	26.78	44.7
4	15.06	79.5
5	9.64	124.2

## Bande diffuser

20W



Flood

h(m)	E(lx)	S_B(sq.m)
1	452.45	5.3
2	113.11	21.2
3	50.27	47.8
4	28.28	84.9
5	18.10	132.7

# Daten zur Beleuchtungsstärke

## Ami-pendant

9W



10°

h(m)	E(lx)	S_B(sq.m)
1	8318.94	0.025
2	2079.74	0.1
3	924.33	0.2
4	519.93	0.4
5	332.76	0.6

## Canos

7W



36°

h(m)	E(lx)	S_B(sq.m)
1	1264.97	0.3
2	316.24	1.2
3	140.55	2.7
4	79.06	4.7
5	50.60	7.4

## Navia

7W



24°

h(m)	E(lx)	S_B(sq.m)
1	2207.84	0.1
2	551.96	0.5
3	245.32	1.2
4	137.99	2.1
5	88.31	3.2

## Mona

12W



17°

h(m)	E(lx)	S_B(sq.m)
1	4386.02	0.1
2	1096.51	0.3
3	487.34	0.7
4	274.13	1.2
5	175.44	1.9

30°

h(m)	E(lx)	S_B(sq.m)
1	2191.34	0.2
2	547.84	0.9
3	243.48	2.1
4	136.96	3.7
5	87.65	5.7

## Marmor

12W



Wallwasher

h(m)	E(lx)	S_B(sq.m)
1	688.68	0.5
2	172.17	2.0
3	76.52	4.5
4	43.04	8.0
5	27.55	12.5

## Polo\_50

15W



20°

h(m)	E(lx)	S_B(sq.m)
1	6928.53	0.1
2	1732.13	0.4
3	769.84	1.0
4	433.03	1.7
5	277.14	2.7

38°

h(m)	E(lx)	S_B(sq.m)
1	2897.45	0.4
2	724.36	1.5
3	321.94	3.3
4	181.09	5.8
5	115.90	9.1

55°

h(m)	E(lx)	S_B(sq.m)
1	1364.51	0.8
2	341.13	3.3
3	151.61	7.5
4	85.28	13.4
5	54.58	20.9

## Polo\_70

25W



15°

h(m)	E(lx)	S_B(sq.m)
1	19004.11	0.1
2	4751.03	0.3
3	2111.57	0.6
4	1187.76	1.0
5	760.16	1.6

24°

h(m)	E(lx)	S_B(sq.m)
1	13170.26	0.1
2	3292.56	0.5
3	1463.36	1.1
4	823.14	1.9
5	526.81	3.0

38°

h(m)	E(lx)	S_B(sq.m)
1	5141.55	0.3
2	1285.39	1.3
3	571.28	3.0
4	321.35	5.4
5	205.66	8.4

# Daten zur Beleuchtungsstärke

## Ami Einbauleuchte

Zoomable 10W



15°

h(m)	E(lx)	S_B(sq.m)
1	2212.77	0.1
2	553.19	0.2
3	245.86	0.5
4	138.30	0.9
5	88.51	1.3

45°

h(m)	E(lx)	S_B(sq.m)
1	2212.77	0.6
2	553.19	2.3
3	245.86	5.1
4	138.30	9.0
5	88.51	14.1

## Ami Einbauleuchte

Filter 10W



10°

h(m)	E(lx)	S_B(sq.m)
1	6810.11	0.025
2	1702.53	0.1
3	756.68	0.2
4	425.63	0.4
5	272.40	0.7