

LIGHTING
FOR ARCHITECTURAL,
HOSPITALITY &
RETAIL APPLICATIONS

-ON

Maga Series Datasheet

Low-Voltage Track

Ami-Zoom



Ami-Filter



Cubo



Dabo



Pixy



Casa



Bande



Bande Diffuser



Ami-Pendant



Canos



Navia

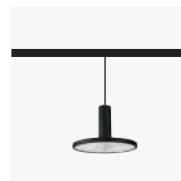

Mona

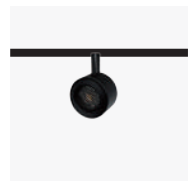

Marmor



Mika



Polo_50



Polo_70



Mains Voltage Recessed

Ami-Round
Zoom



Ami-Rectangle
Zoom

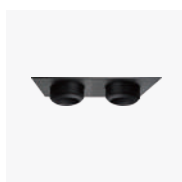

Ami-Square
Zoom

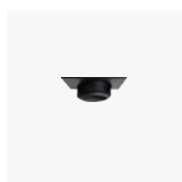

Ami-Round
Filter

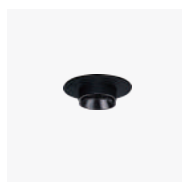

Ami-Rectangle
Filter

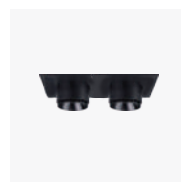

Ami-Square
Filter

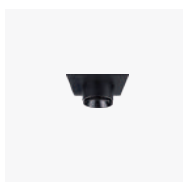

Ami-Zoom Low-Voltage Track



- White
- Black

Features

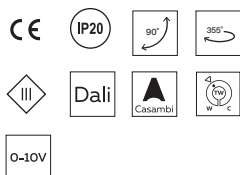

Dimensions

M403

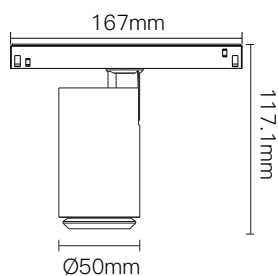

M412

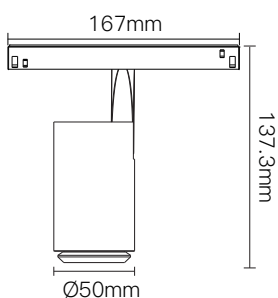

Electrical system

Total power consumption:	10W
Power input:	48V
Operating temperature:	-10°C ~ 35°C
Dimming option:	0-10V / Dali / Casambi
Insulation class:	Class III

Light source

LED type:	COB
CCT:	2700K/3000K/4000K
CRI:	Ra>90
Beam angle:	18°-45°
UGR:	<16

Housing

Lamp body diameter:	50mm
Material:	Aluminum
Weight:	271.4g

Warranty

Period:	5-year warranty
----------------	-----------------

Lumen output

BA. \ CCT	2700K	3000K	4000K
18°-45°	288lm	320lm	350lm

Nomenclature

*Applicable model: M40310xx90xxxxx (xx: dynamic codes)

Product Code	System Power	CCT	CRI	Beam Angle	Driver/Control	Serial No.
M403	10(10W)	27(2700K)	90(90)	Z2(18°-45°)	N(Non-Dim)	01(Black)
M412		30(3000K)			A(0-10V dim)	02(White)
		40(4000K)			D(Dali dim)	
		TW(Tunable)				

Ami-Filter Low-Voltage Track



- White
- Black

Features

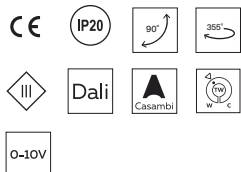

Dimensions

M404

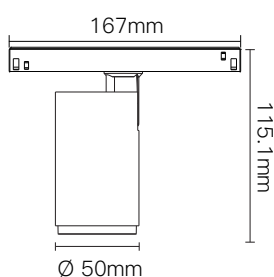

M413

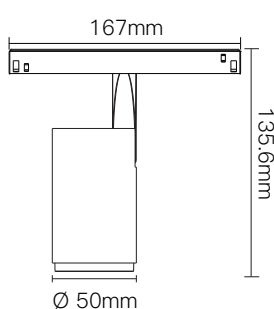

Electrical system

Total power consumption:	9W
Power input:	48V
Operating temperature:	-10°C ~ 35°C
Dimming option:	0-10V / Dali / Casambi
Insulation class:	Class III

Light source

LED type:	SMD
CCT:	2700K/3000K/4000K
CRI:	Ra>90
Beam angle:	7° / 15° / 24° / 38° / 10°x35° / Honeycomb
UGR:	<16

Housing

Lamp body diameter:	50mm
Material:	Aluminum
Weight:	255.6g

Warranty

Period:	5-year warranty
----------------	-----------------

Lumen output

* The lumen output is measured by the original optics (7°).

BA. \ CCT	2700K	3000K	4000K
7°	450lm	500lm	550lm

Nomenclature

*Applicable model: M40409xx90xxxx (xx: dynamic codes)

Product Code	System Power	CCT	CRI	Beam Angle	Driver/Control	Serial No.
M404	09(09W)	27(2700K)	90(90)	07(7°)	N(Non-Dim)	01(Black)
M413		30(4000K)		15(15°)	A(0-10V dim)	02(White)
		40(4000K)		24(24°)	D(Dali dim)	
				38(38°)		
				X1(10°x35°)		
				HC(Honeycomb)		
				TW(Tunable)		
				18(18°)		
				24(24°)		
				38(38°)		

Cubo Low-Voltage Track



Electrical system

Total power consumption:	9W
Power input:	48V
Operating temperature:	-10°C ~ 35°C
Dimming option:	0-10V / Dali / Casambi
Insulation class:	Class III

Light source

LED type:	SMD
CCT:	2700K/3000K/4000K
CRI:	Ra>90
Beam angle:	7°/15° /24° /38° /10°x35° /Honeycomb
UGR:	<16

- White
- Black

Features

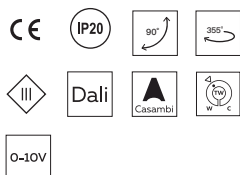

Housing

Lamp body diameter:	56.3mm x 56.3mm
Material:	Aluminum
Weight:	304.6g

Warranty

Period:	5-year warranty
----------------	-----------------

Dimensions

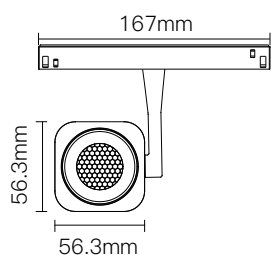

Lumen output * The lumen output is measured by the original optics (7°).

BA. \ CCT	2700K	3000K	4000K
7°	405lm	450lm	500lm

Nomenclature

*Applicable model: M40510xx90xxxx (xx: dynamic codes)

Product Code	System Power	CCT	CRI	Beam Angle	Driver/Control	Serial No.	
M405	09(9W)	27(2700K)	90(90)	07(7°)	N(Non-Dim)	01(Black)	
		30(3000K)		15°(15°)		A(0-10V dim)	02(White)
		40(4000K)		24°(24°)	D(Dali dim)		
				38°(38°)			
		X1(10°x35°)		HC(Honeycomb)			
		TW(Tunable)					18(18°)
		24(24°)					
							38(38°)

Dabo Low-Voltage Track



- White
● Black

Features



Dimensions

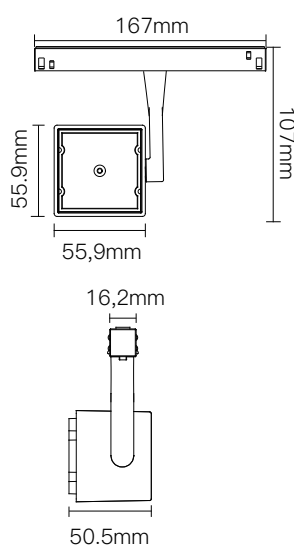

Electrical system

Total power consumption:	10W
Power input:	48V
Operating temperature:	-10°C ~ 35°C
Dimming option:	0-10V / Dali / Casambi
Insulation class:	Class III

Light source

LED type:	SMD
CCT:	2700K/3000K/4000K
CRI:	Ra>90
Beam angle:	10°
UGR:	<16

Housing

Lamp body diameter:	55,9mm x 55,9mm
Material:	Aluminum
Weight:	266g

Warranty

Period:	5-year warranty
----------------	-----------------

Lumen output

BA. \ CCT	2700K	3000K	4000K
10°	504lm	560lm	616lm

Nomenclature

*Applicable model: M40610xx90xxxx (xx: dynamic codes)

Product Code	System Power	CCT	CRI	Beam Angle	Driver/Control	Serial No.	
M406	10(10W)	27(2700K)	90(90)	10(10°)	N(Non-Dim)	01(Black)	
		30(3000K)				A(0-10V dim)	02(White)
		40(4000K)				D(Dali dim)	

Pixy Low-Voltage Track



Electrical system

Total power consumption:	7W
Power input:	48V
Operating temperature:	-10°C ~ 35°C
Dimming option:	0-10V / Dali / Casambi
Insulation class:	Class III

Light source

LED type:	COB
CCT:	2700K/3000K/4000K
CRI:	Ra>90
Beam angle:	Wash wall
UGR:	<19

- White
● Black

Features



Dimensions

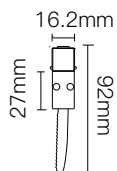
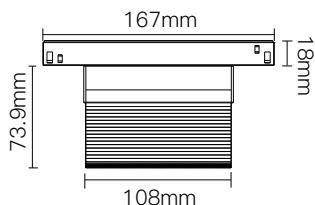

Housing

Lamp body diameter:	108mm x 73,9mm
Material:	Aluminum+PMMA
Weight:	178.8g

Warranty

Period:	5-year warranty
----------------	-----------------

Lumen output

BA. \ CCT	2700K	3000K	4000K
Wall wash	504lm	560lm	610lm

Nomenclature

*Applicable model: M40107xx90xxxx (xx: dynamic codes)

Product Code	System Power	CCT	CRI	Beam Angle	Driver/Control	Serial No.
M401	07(7W)	27(2700K)	90(90)	WW(Wall Wsah)	N(Non-Dim)	01(Black)
		30(3000K)			A(0-10V dim)	02(White)
		40(4000K)			D(Dali dim)	

Casa Low-Voltage Track



Electrical system

Total power consumption:	12W
Power input:	48V
Operating temperature:	-10°C ~ 35°C
Dimming option:	0-10V / Dali / Casambi
Insulation class:	Class III

Light source

LED type:	SMD
CCT:	2700K/3000K/4000K
CRI:	Ra>90
Beam angle:	Asymmetric (30°)
UGR:	<19

- White
● Black

Features



Dimensions

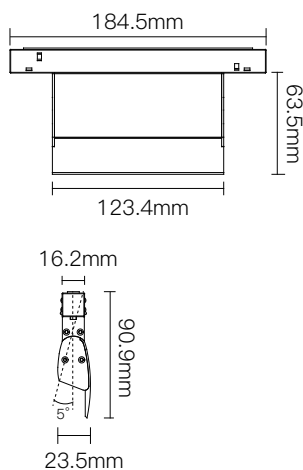

Housing

Lamp body diameter:	63,5mm x 123,4mm
Material:	Aluminum
Weight:	212.5g

Warranty

Period:	5-year warranty
----------------	-----------------

Lumen output

BA. \ CCT	2700K	3000K	4000K
30°	468lm	520lm	570lm

Nomenclature

*Applicable model: M40212xx90xxxx (xx: dynamic codes)

Product Code	System Power	CCT	CRI	Beam Angle	Driver/Control	Serial No.	
M402	12(12W)	27(2700K)	90(90)	30(30°)	N(Non-Dim)	01(Black)	
		30(3000K)				A(0-10V dim)	02(White)
		40(4000K)				D(Dali dim)	

Bande Low-Voltage Track



- White
● Black

Features

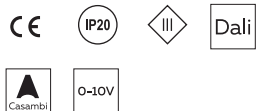

Dimensions

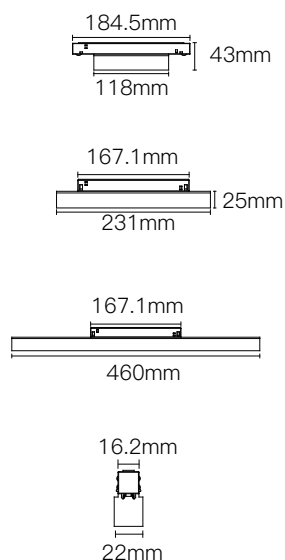

Electrical system

Total power consumption:	6W / 10W / 20W
Power input:	48V
Operating temperature:	-10°C ~ 35°C
Dimming option:	0-10V / Dali / Casambi
Insulation class:	Class III

Light source

LED type:	SMD
CCT:	2700K/3000K/4000K
CRI:	Ra>90
Beam angle:	38°
UGR:	<16

Housing

Lamp body diameter:	118mm x 22mm / 231mm x 22mm / 460mm x 22mm
Material:	Aluminum
Weight:	110.3g / 178.2g / 316.5g

Warranty

Period:	5-year warranty
----------------	-----------------

Lumen output

BA. \ CCT	2700K	3000K	4000K
38° (6W)	315lm	350lm	385lm
38° (11W)	450lm	500lm	550lm
38° (20W)	990lm	1100lm	1210lm

Nomenclature

*Applicable model: M410xxx90xxxx (xx: dynamic codes)

Product Code	System Power	CCT	CRI	Beam Angle	Driver/Control	Serial No.
M410	06(6W)	27(2700K)	90(90)	38(38°)	N(Non-Dim)	01(Black)
	11(11W)	30(3000K)			A(0-10V dim)	02(White)
	20(20W)	40(4000K)			D(Dali dim)	

Bande Diffuser Low-Voltage Track



- White
- Black

Features

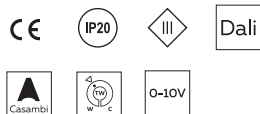

Dimensions

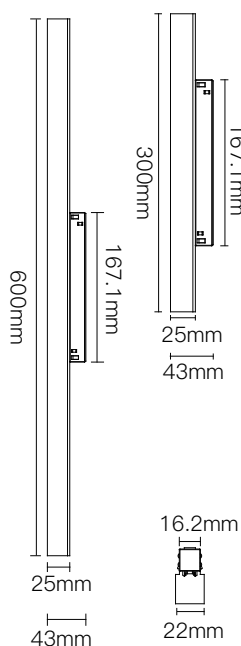

Electrical system

Total power consumption:	11W / 20W
Power input:	48V
Operating temperature:	-10°C ~ 35°C
Dimming option:	0-10V / Dali / Casambi
Insulation class:	Class III

Light source

LED type:	SMD
CCT:	2700K/3000K/4000K
CRI:	Ra>90
Beam angle:	Flood
UGR:	<16

Housing

Lamp body diameter:	300mm x 22mm / 600mm x 22mm
Material:	Aluminum
Weight:	199.3g /313.8g

Warranty

Period:	5-year warranty
----------------	-----------------

Lumen output

BA. \ CCT	2700K	3000K	4000K
Flood (11W)	459lm	510lm	560lm
Flood (20W)	945lm	1050lm	1155lm
Glarefree-W (11W)	322lm	357lm	392lm
Glarefree-W (20W)	662lm	735lm	809lm

Nomenclature

*Applicable model: M411xxxx90xxxx (xx: dynamic codes)

Product Code	System Power	CCT	CRI	Beam Angle	Driver/Control	Serial No.
M411	11(11W)	27(2700K)	90(90)	FD(Flood)	N(Non-Dim)	01(Black)
	20(20W)	30(3000K)		GW(Glarefree-W)	A(0-10V dim)	02(White)
		40(4000K)			D(Dali dim)	
		TW(Tunable)				

Ami Pendant Low-Voltage Track



- White
● Black

Features



Dimensions

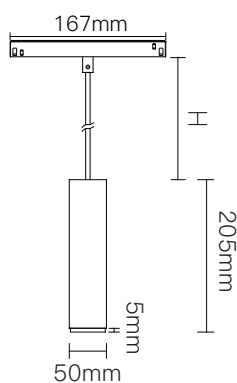

Electrical system

Total power consumption:	9W
Power input:	48V
Operating temperature:	-10°C ~ 35°C
Dimming option:	0-10V / Dali / Casambi
Insulation class:	Class III

Light source

LED type:	SMD
CCT:	2700K/3000K/4000K
CRI:	Ra>90
Beam angle:	7° /15° /24° /38° /10°x35° /Honeycomb
UGR:	<19

Housing

Lamp body diameter:	50mm
Material:	Aluminum
Weight:	425g

Warranty

Period:	5-year warranty
----------------	-----------------

Lumen output

BA. \ CCT	2700K	3000K	4000K
7°	369lm	410lm	450lm

Nomenclature

*Applicable model: M40713xx90xxxxx (xx: dynamic codes)

Product Code	System Power	CCT	CRI	Beam Angle	Driver/Control	Serial No.
M407	09(9W)	27(2700K)	90(90)	07(7°)	N(Non-Dim)	01(Black)
		30(3000K)		15(15°)	A(0-10V dim)	02(White)
		40(4000K)		24(24°)	D(Dali dim)	
				38(38°)		
				X1(10°x35°)		
				HC(Honeycomb)		
		TW(Tunable)		18(18°)		
				24(24°)		
				38(38°)		

Canos Low-Voltage Track



- White
● Black

Features

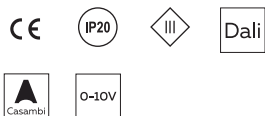

Dimensions

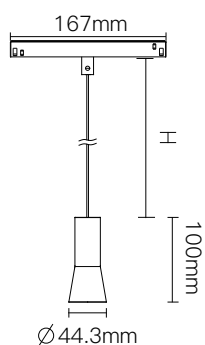

Electrical system

Total power consumption:	7W
Power input:	48V
Operating temperature:	-10°C ~ 35°C
Dimming option:	0-10V / Dali / Casambi
Insulation class:	Class III

Light source

LED type:	COB
CCT:	2700K/3000K/4000K
CRI:	Ra>90
Beam angle:	15° /24° /36°
UGR:	<16

Housing

Lamp body diameter:	44,3mm
Material:	Aluminum
Weight:	173.9g

Warranty

Period:	5-year warranty
----------------	-----------------

Lumen output

BA. \ CCT	2700K	3000K	4000K
15°	324lm	360lm	396lm
24°	360lm	400lm	440lm
38°	342lm	380lm	420lm

Nomenclature

*Applicable model: M40807xx90xxxx (xx: dynamic codes)

Product Code	System Power	CCT	CRI	Beam Angle	Driver/Control	Serial No.
M408	07(7W)	27(2700K)	90(90)	15(15°)	N(Non-Dim)	01(Black)
		30(3000K)		24(24°)	A(0-10V dim)	02(White)
		40(4000K)		36(36°)	D(Dali dim)	

Navia Low-Voltage Track



- White
● Black

Features

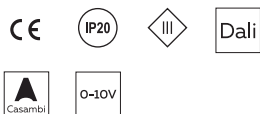

Dimensions

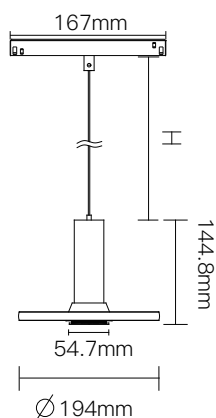

Electrical system

Total power consumption:	7W
Power input:	48V
Operating temperature:	-10°C ~ 35°C
Dimming option:	0-10V / Dali / Casambi
Insulation class:	Class III

Light source

LED type:	COB
CCT:	2700K/3000K/4000K
CRI:	Ra>90
Beam angle:	24°
UGR:	<16

Housing

Lamp body diameter:	194mm
Material:	Aluminum
Weight:	430.4g

Warranty

Period:	5-year warranty
----------------	-----------------

Lumen output

BA. \ CCT	2700K	3000K	4000K
24°	360lm	400lm	440lm

Nomenclature

*Applicable model: M40913xx90xxxx (xx: dynamic codes)

Product Code	System Power	CCT	CRI	Beam Angle	Driver/Control	Serial No.
M409	07(7W)	27(2700K)	90(90)	24(24°)	N(Non-Dim)	01(Black)
		30(3000K)			A(0-10V dim)	02(White)
		40(4000K)			D(Dali dim)	

Mona

Low-Voltage Track



- White
- Black

Features



Dimensions

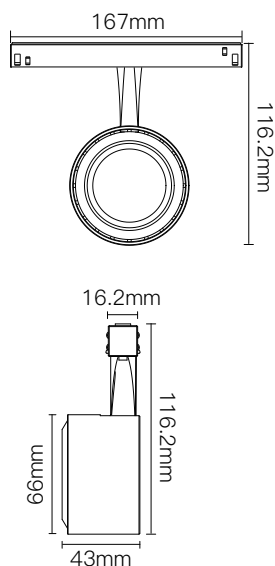

Electrical system

Total power consumption:	12W
Power input:	48V
Operating temperature:	-10°C ~ 35°C
Dimming option:	0-10V / Dali / Casambi
Insulation class:	Class III

Light source

LED type:	COB
CCT:	2700K/3000K/4000K
CRI:	Ra>92
Beam angle:	17°/30°
UGR:	<16

Housing

Lamp body diameter:	66mm
Material:	Aluminum
Weight:	230g

Warranty

Period:	5-year warranty
----------------	-----------------

Lumen output

BA. \ CCT	2700K	3000K	4000K
17°	620lm	650lm	689lm
30°	620lm	650lm	689lm

Nomenclature

*Applicable model: M41412xx90xxxx (xx: dynamic codes)

Product Code	System Power	CCT	CRI	Beam Angle	Driver/Control	Serial No.
M414	12(12W)	27(2700K)	90(90)	17(17°)	N(Non-Dim)	01(Black)
		30(3000K)		30(30°)	A(0-10V dim)	02(White)
		40(4000K)			D(DT6)	
					E(DT8)	

Marmor

Low-Voltage Track



- White
● Black

Features



Dimensions

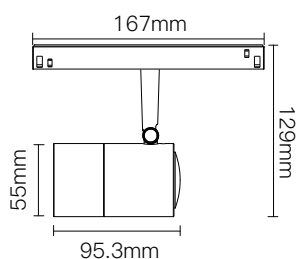

16.2mm

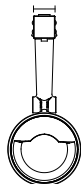

Electrical system

Total power consumption:	12W
Power input:	48V
Operating temperature:	-10°C ~ 35°C
Dimming option:	0-10V / Dali / Casambi
Insulation class:	Class III

Light source

LED type:	COB
CCT:	2700K/3000K/4000K
CRI:	Ra>92
Beam angle:	Wallwash
UGR:	NA

Housing

Lamp body diameter:	55mm
Material:	Aluminum
Weight:	293g

Warranty

Period:	5-year warranty
----------------	-----------------

Lumen output

BA. \ CCT	2700K	3000K	4000K
Wallwasher	515lm	541lm	573lm

Nomenclature

*Applicable model: M41512xx90xxxx (xx: dynamic codes)

Product Code	System Power	CCT	CRI	Beam Angle	Driver/Control	Serial No.
M415	12(12W)	27(2700K)	90(90)	WW(Wallwash)	N(Non-Dim)	01(Black)
		30(3000K)			A(0-10V dim)	02(White)
		40(4000K)			D(DT6)	
					E(DT8)	

Mika

Low-Voltage Track



● Black

Features



Dimensions

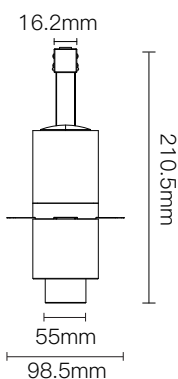
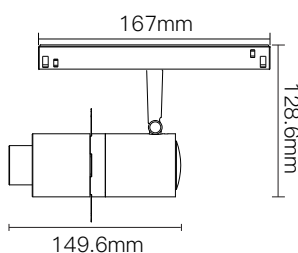

Electrical system

Total power consumption:	12W
Power input:	48V
Operating temperature:	-10°C ~ 35°C
Dimming option:	0-10V / Dali / Casambi
Insulation class:	Class III

Light source

LED type:	COB
CCT:	2700K/3000K/4000K
CRI:	Ra>90
Beam angle:	Beam shaper
UGR:	<10

Housing

Lamp body diameter:	55mm
Material:	Aluminum
Weight:	431g

Warranty

Period:	5-year warranty
----------------	-----------------

Lumen output

BA. \ CCT	2700K	3000K	4000K
Beam shaper	300lm	300lm	315lm

Nomenclature

*Applicable model: M41612xx90xxxx (xx: dynamic codes)

Product Code	System Power	CCT	CRI	Beam Angle	Driver/Control	Serial No.
M416	12(12W)	27(2700K)	90(90)	SP(Shaper)	N(Non-Dim)	01(Black)
		30(3000K)			A(0-10V dim)	
		40(4000K)			D(DT6)	
					E(DT8)	

Polo_50

Low-Voltage Track



- White
● Black

Features



Dimensions

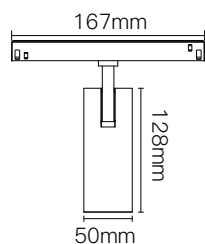

16.2mm

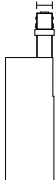

Electrical system

Total power consumption:	15W
Power input:	48V
Operating temperature:	-10°C ~ 35°C
Dimming option:	0-10V / Dali / Casambi
Insulation class:	Class III

Light source

LED type:	COB
CCT:	2700K/3000K/4000K
CRI:	Ra>92
Beam angle:	20°/38°/55°
UGR:	<19

Housing

Lamp body diameter:	50mm
Material:	Aluminum
Weight:	350g

Warranty

Period:	5-year warranty
----------------	-----------------

Lumen output

BA. \ CCT	2700K	3000K	4000K
20°	1189lm	1248lm	1323lm
38°	1215lm	1276lm	1353lm
55°	1079lm	1133lm	1200lm

Nomenclature

*Applicable model: M41715xx90xxxx (xx: dynamic codes)

Product Code	System Power	CCT	CRI	Beam Angle	Driver/Control	Serial No.
M417	15(15W)	27(2700K)	90(90)	20(20°)	N(Non-Dim)	01(Black)
		30(3000K)		38(38°)	A(0-10V dim)	02(White)
		40(4000K)		55(55°)	D(DT6)	
					E(DT8)	

Polo_70

Low-Voltage Track



- White
● Black

Features



Dimensions

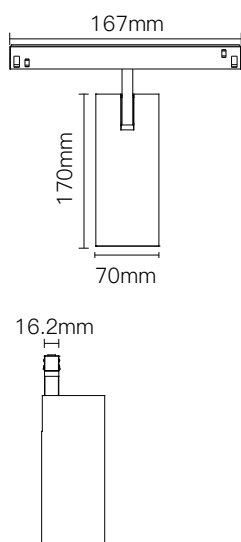

Electrical system

Total power consumption:	25W
Power input:	48V
Operating temperature:	-10°C ~ 35°C
Dimming option:	0-10V / Dali / Casambi
Insulation class:	Class III

Light source

LED type:	COB
CCT:	2700K/3000K/4000K
CRI:	Ra>92
Beam angle:	15°/24°/36°
UGR:	<19

Housing

Lamp body diameter:	70mm
Material:	Aluminum
Weight:	580g

Warranty

Period:	5-year warranty
----------------	-----------------

Lumen output

BA. \ CCT	2700K	3000K	4000K
15°	1869lm	1962lm	2080lm
24°	1954lm	2052lm	2175lm
36°	1914lm	2010lm	2131lm

Nomenclature

*Applicable model: M41815xx90xxxx (xx: dynamic codes)

Product Code	System Power	CCT	CRI	Beam Angle	Driver/Control	Serial No.
M418	25(25W)	27(2700K)	90(90)	15(15°)	N(Non-Dim)	01(Black)
		30(3000K)		24(24°)		A(0-10V dim)
		40(4000K)		36(36°)	D(DT6)	
					E(DT8)	

Ami-Round Mains Voltage Recessed

Zoom



Motorised Downlight.
Integrated power supply.

- White
 Black

Features



Dimensions

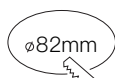
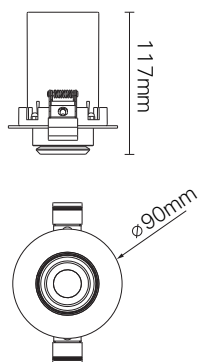

Electrical system

Total power consumption:	10W
Power input:	220Vac
Operating temperature:	-10°C ~ 35°C
Power factor:	>0.95
Dimming option:	0-10V / Dali / Casambi
Insulation class:	Class II

Light source

LED type:	COB
CCT:	2700K/3000K/4000K
CRI:	Ra>90
Beam angle:	18°-45°
UGR:	<16

Housing

Dimension:	90mm X 117mm
Material:	Aluminum
Weight:	445g

Warranty

Period:	5-year warranty
----------------	-----------------

Lumen output

BA. \ CCT	2700K	3000K	4000K
18°-45°	290lm	320lm	350lm

Nomenclature

*Applicable model: M20110xx90xxxx (xx: dynamic codes)

Product Code	System Power	CCT	CRI	Beam Angle	Driver/Control	Serial No.	
M201	10(10W)	27(2700K)	90(90)	Z2(18°-45°)	N(Non-Dim)	01(Black)	
		30(3000K)				A(0-10V dim)	02(White)
		40(4000K)				D(Dali dim)	
		TW(Tunable)					

Ami-Rectangle Mains Voltage Recessed

Zoom



Motorised Downlight.
Integrated power supply.

- White
 Black

Features



Dimensions

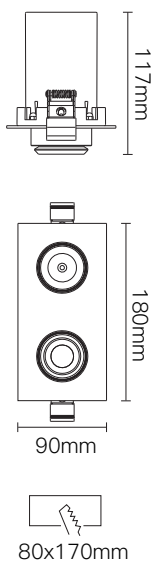

Electrical system

Total power consumption:	10W*2
Power input:	220Vac
Operating temperature:	-10°C ~ 35°C
Power factor:	>0.95
Dimming option:	0-10V / Dali /Casambi
Insulation class:	Class II

Light source

LED type:	COB
CCT:	2700K/3000K/4000K
CRI:	Ra>90
Beam angle:	18°-45°
UGR:	<16

Housing

Dimension:	180mm X 90mm X 117mm
Material:	Aluminum
Weight:	885g

Warranty

Period:	5-year warranty
----------------	-----------------

Lumen output

BA. \ CCT	2700K	3000K	4000K
18°-45°	290lm*2	320lm*2	350lm*2

Nomenclature

*Applicable model: M20320xx90xxxx (xx: dynamic codes)

Product Code	System Power	CCT	CRI	Beam Angle	Driver/Control	Serial No.
M202	20(20W)	27(2700K) 30(3000K) 40(4000K)	90(90)	Z2(18°-45°)	N(Non-Dim) A(0-10V dim) D(Dali dim)	01(Black) 02(White)
		TW(Tunable)				

Ami-Square Mains Voltage Recessed

Zoom



Motorised Downlight.
Integrated power supply.

- White
 Black

Features



Dimensions

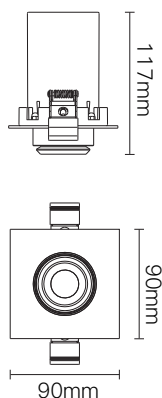

ø82mm

Electrical system

Total power consumption:	10W
Power input:	220Vac
Operating temperature:	-10°C ~ 35°C
Power factor:	>0.95
Dimming option:	0-10V / Dali / Casambi
Insulation class:	Class II

Light source

LED type:	COB
CCT:	2700K/3000K/4000K
CRI:	Ra>90
Beam angle:	18°-45°
UGR:	<16

Housing

Dimension:	90mm X 90mm X 117mm
Material:	Aluminum
Weight:	420g

Warranty

Period:	5-year warranty
----------------	-----------------

Lumen output

BA. \ CCT	2700K	3000K	4000K
18°-45°	290lm	320lm	350lm

Nomenclature

*Applicable model: M20310xx90xxxx (xx: dynamic codes)

Product Code	System Power	CCT	CRI	Beam Angle	Driver/Control	Serial No.
M203	10(10W)	27(2700K)	90(90)	Z2(18°-45°)	N(Non-Dim)	01(Black)
		30(3000K)			A(0-10V dim)	02(White)
		40(4000K)			D(Dali dim)	
		TW(Tunable)				

Ami-Round

Mains Voltage Recessed Filter



Motorised Downlight.
Integrated power supply.

- White
 Black

Features

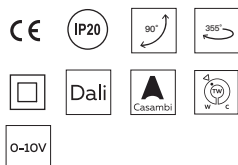

Dimensions

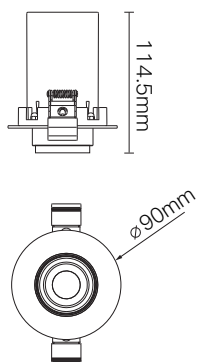

Electrical system

Total power consumption:	10W
Power input:	220Vac
Operating temperature:	-10°C ~ 35°C
Power factor:	>0.95
Dimming option:	0-10V / Dali / Casambi
Insulation class:	Class II

Light source

LED type:	SMD
CCT:	2700K/3000K/4000K
CRI:	Ra>90
Beam angle:	15° /24° /38° /10°x35° /Honeycomb
UGR:	<16

Housing

Dimension:	90mm X 114,5mm
Material:	Aluminum
Weight:	445g

Warranty

Period:	5-year warranty
----------------	-----------------

Lumen output * The lumen output is measured by the original optics (7°).

BA. \ CCT	2700K	3000K	4000K
7°	370lm	410lm	450lm

Nomenclature

*Applicable model: M2040xx90xxxx (xx: dynamic codes)

Product Code	System Power	CCT	CRI	Beam Angle	Driver/Control	Serial No.	
M204	10(10W)	27(2700K)	90(90)	07(7°)	N(Non-Dim)	01(Black)	
		30(3000K)		15°(15°)	A(0-10V dim)	02(White)	
		40(4000K)		24°(24°)	D(Dali dim)		
				38°(38°)			
				X1(10°x35°)			
				HC(Honeycomb)			
				TW(Tunable)	18(18°)		
					24(24°)		
					38(38°)		

Ami-Rectangle Mains Voltage Recessed Filter



Motorised Downlight.
Integrated power supply.

- White
● Black

Features



Dimensions

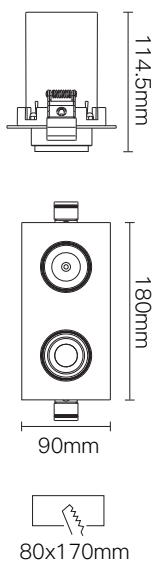

Electrical system

Total power consumption:	10W*2
Power input:	220Vac
Operating temperature:	-10°C ~ 35°C
Power factor:	>0.95
Dimming option:	0-10V / Dali /Casambi
Insulation class:	Class II

Light source

LED type:	SMD
CCT:	2700K/3000K/4000K
CRI:	Ra>90
Beam angle:	15° /24° /38° /10°x35° /Honeycomb
UGR:	<16

Housing

Dimension:	90mm X 180mm X 114,5mm
Material:	Aluminum
Weight:	885g

Warranty

Period:	5-year warranty
----------------	-----------------

Lumen output * The lumen output is measured by the original optics (7°).

BA. \ CCT	2700K	3000K	4000K
7°	370lm*2	410lm*2	450lm*2

Nomenclature

*Applicable model: M20520xx90xxxx (xx: dynamic codes)

Product Code	System Power	CCT	CRI	Beam Angle	Driver/Control	Serial No.
M205	20(20W)	27(2700K)	90(90)	07(7°)	N(Non-Dim)	01(Black)
		30(3000K)		15°(15°)	A(0-10V dim)	02(White)
		40(4000K)		24°(24°)	D(Dali dim)	
				38°(38°)		
				X1(10°x35°)		
				HC(Honeycomb)		
				TW(Tunable)		
				18(18°)		
				24(24°)		
				38(38°)		

Ami-Square Mains Voltage Recessed Filter



Motorised Downlight.
Integrated power supply.

- White
● Black

Features



Dimensions

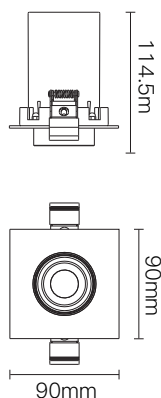

ø82mm

Electrical system

Total power consumption:	10W
Power input:	220Vac
Operating temperature:	-10°C ~ 35°C
Power factor:	>0.95
Dimming option:	0-10V / Dali / Casambi
Insulation class:	Class II

Light source

LED type:	SMD
CCT:	2700K/3000K/4000K
CRI:	Ra>90
Beam angle:	15° /24° /38° /10°x35° /Honeycomb
UGR:	<16

Housing

Dimension:	90mm X 90mm X 114,5mm
Material:	Aluminum
Weight:	420g

Warranty

Period:	5-year warranty
----------------	-----------------

Lumen output * The lumen output is measured by the original optics (7°).

BA. \ CCT	2700K	3000K	4000K
7°	370lm	410lm	450lm

Nomenclature

*Applicable model: M20610xx90xxxx (xx: dynamic codes)

Product Code	System Power	CCT	CRI	Beam Angle	Driver/Control	Serial No.	
M206	10(10W)	27(2700K)	90(90)	07(7°)	N(Non-Dim)	01(Black)	
		30(3000K)		15°(15°)	A(0-10V dim)	02(White)	
		40(4000K)		24°(24°)	D(Dali dim)		
				38°(38°)			
				X1(10°x35°)			
				HC(Honeycomb)			
				TW(Tunable)	18(18°)		
					24(24°)		
					38(38°)		