

Surface Mounted Light Installation Instructions

RoboRadar Applicable model: R20120xx90xxxxx



WARNING: RISK OF ELECTRIC SHOCK! TURN OFF POWER BEFORE INSTALLING OR SERVICING.

WARNING:

1. Risk of fire or electric shock. LED fixtures installation requires knowledge of electrical luminaires systems. Installation should be performed only by a qualified electrician in accordance with the National Electrical Code and relevant local code.
2. Read all product labels and instructions before installing the fixture.
3. To prevent wiring damage or abrasion, do not expose wiring to edges of sheet metal or other sharp objects.
4. **THE INSTALLATION SHOULD ONLY BE PERFORMED AFTER THE POWER OF THE FIXTURE HAS BEEN DISCONNECTED.**
5. **SAVE THESE INSTRUCTION FOR FIXTURE REFERENCE.**



220-240 VAC



INDOOR
USE ONLY.



DO NOT TOUCH
WHILE FIXTURE
IS IN OPERATION.

Luminaire Installation

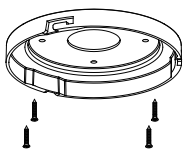

1 Ceiling plate x1

2 Screw x4

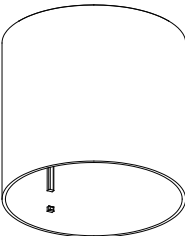

3 Lamp housing x1

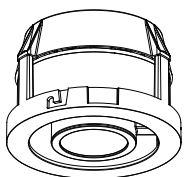

4 Lamp body x1



ON Lichttechnik GmbH
Siegbergstraße 73
57072 Siegen
T +49 (0) 271 233 749-61
E info@on-lichttechnik.de
on-lichttechnik.de

Surface Mounted Light Installation Instructions

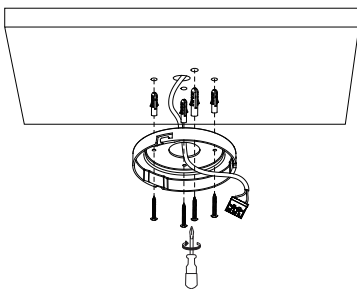

- 1 Pull the AC cable out of the ceiling plate. Adjusting the ceiling plate to a suitable position, drill the mounting holes and use screws to fix the plate

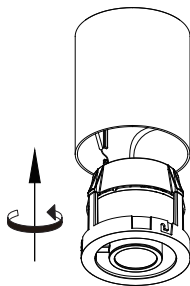

- 2 Align the slot of the lamp body with the tenon of the lamp housing, and secure it clockwise into the lamp housing.

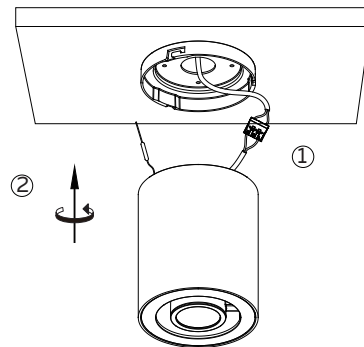

- 3 Connect the fixture to the AC power supply. Insert the fixture in the ceiling plate and twist, making sure the lugs engage fully in the latching slots.

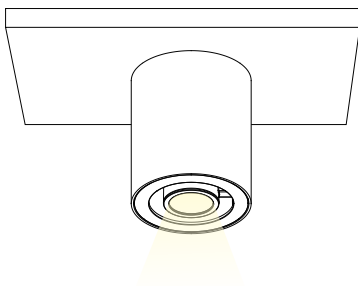

- 4 Restore the power supply.

